



Q SERIES

230-305 HP

VALTRA

YOUR WORKING MACHINE

WE WORK HARD TO MAKE HARD WORK EASY

For over 70 years, Valtra has been working with farmers to develop reliable tractors and cutting-edge technology. At Valtra, our mission is to understand and anticipate your needs, and to provide you with the best tractor experience possible.

Modern farming and contracting call for versatility, power, and precision. As well as needing the power to work with any implement smoothly and efficiently, you require a machine that has the brains to know how to yield that power, and the reliability, durability, and low total cost of ownership that will make your business a success.

THE ALL NEW Q SERIES

The Q Series is a pleasure to work with and a driver's dream. It offers the perfect combination of power, practicality, precision, and performance for enhanced efficiency and profitability. The Q Series is a Quality tractor with a capital Q. That's why Q certified dealers are the only professionals qualified to serve your needs. They represent the best knowledge, service, and aftersales capabilities to ensure you get the maximum benefit from the Q Series' favourable total cost of ownership and smart farming advantages.

When your business needs a machine with enough power to handle every task and utilise any implement, the Q Series' 7.4-litre 6-cylinder engine and CVT transmission deliver the power you need when you need it. Consistent torque and high power delivery means you always have the output to get the job done.

At just 337 cm tall (with Valtra Guide) and with a 300.5 cm wheelbase, the Q Series is a perfectly proportioned Beast that is stable in the field and smooth on the road.

Everything about the Q Series is intelligently designed to maximise visibility and all-day comfort - the easily accessible cab via the robust self-cleaning aluminium steps, the 270-degree wiper, side window wiper, dynamically sloping hood, and cleverly placed air intake and exhaust.

Valtra's famously easy to use smart technology comes as standard and is seamlessly integrated into the driver's cab and ergonomically placed for ultimate convenience and ease of use. SmartTouch

user profiles make switching between drivers and tasks quick and easy. Advanced telemetry allows easy and seamless fleet management and FMIS integration. Data shared with Q certified dealers enables remote diagnostics to predict maintenance needs in advance, ensuring 101% up time. Get more done and do it well with the Quality Q Series.



CONTENTS

- 2 We work hard to make hard work easy
- 2 The all new Q Series
- 4 Thinks like a pro.
Works like a beast
- 6 **WORKS LIKE A BEAST:
Smart power**
 - 8 A Trusted transmission
 - 10 Superior suspension
 - 12 Heavy-weight hydraulics
 - 14 Work late. Work light.
 - 16 A well balanced beast
 - 18 Complete comfort
- 20 **THINKS LIKE A PRO:
Smart technology**
 - 22 Technology at your fingertips
 - 24 Machine Management
 - 26 Only uptime
 - 28 Unlimited possibilities
 - 30 Q Series technical specifications

THINKING LIKE A PRO

INTEGRATED SMART FARMING



Smart technology is fully integrated into the Q Series. In-cab technologies like Valtra Guide, Section Control with Multiboom, Variable Rate Control, Valtra U-Pilot headland management, SmartTurn and ISOBUS features are simply controlled with the award-winning SmartTouch interface which is easier to use than your smartphone.

Advanced telemetry with Valtra Connect and technologies such as Agrirouter and TaskDoc Pro makes fleet management, managing tasks and working with FMIS smooth and efficient. The Q Series is an easy-to-use, intelligent machine built for professionals.

WORKING LIKE A BEAST

The Q Series' 7.4 litre AGCO Power engine has exactly the right displacement for this hp tractor. The smooth and efficient stepless CVT transmission directs this power when and where it is needed. Maximum power at low revs means smooth and efficient pulling while maintaining fuel

economy. The 200+ litre hydraulic pump and 75-litre exportable hydraulic oil capacity ensure the Q Series can work with any implement. The hydraulic ECO option enables maximum flow to be reached at 1650 rpm, making the Q Series an intelligent and efficient Beast of a machine.

7.4 L AGCO Power



THINKS LIKE A PRO. WORKS LIKE A BEAST.

Power without direction is useless. You need to have focus and the intelligence to apply that power effectively and efficiently. The Q Series is a high horsepower tractor with the technology to accomplish any smart farming task. Think of it as a high-quality precision tool for increasing productivity and profitability.

1. THE BEST BEAST

THE BEST SMART FARMING HIGH HORSEPOWER TRACTOR ON THE MARKET.

Quality with a capital Q! The Q Series gives you the smoothest ride with the best fuel economy from its market-leading, 7.4 litre AGCO Power engine and the best tried and tested CVT transmission on the market. SmartTouch guarantees you have the easiest ride by intelligently optimising and directing the Q's power to where it's needed.

PAGE 6-9 AND PAGE 20-22

2. A PRO OF POWER AND PROFIT

A BEAST BUILT FOR BUSINESS WITH THE POWER, INTELLIGENCE, AND VERSATILITY TO MAXIMISE PRODUCTIVITY.

Do you know how to save money? The Q does! Favourable total cost of ownership, the versatility to do more, and the smart farming technology to do it efficiently make the Q Series a Pro when it comes to maximising profits.

PAGE 8 AND PAGE 10

3. 101% UPTIME AND COMPLETE CONTROL

YOUR HIGH-QUALITY MACHINE DESERVES HIGH-QUALITY SERVICE.

Only Q certified dealers are qualified to serve your business needs, keeping you working day in and day out. They are the best of the best, offering flexible finance options for complete cost control, expert knowledge, and 100% connected availability to guarantee 101% uptime.

PAGE 26

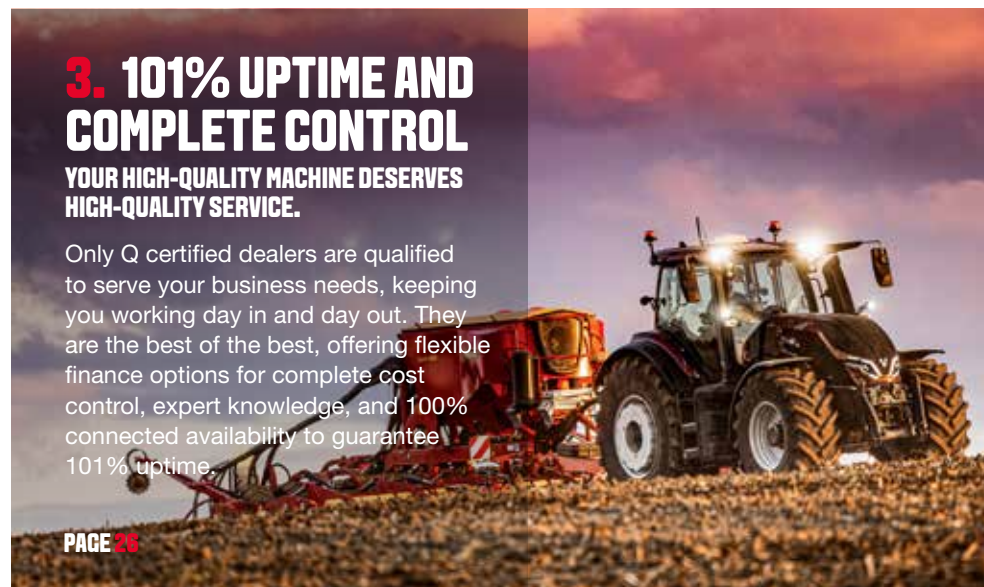

4. COMFORT AND CONVENIENCE

ENJOYABLE TO DRIVE, EASY TO OPERATE AND A PLEASURE TO WORK WITH.

For your long days in the cab nothing is as comfortable as the Q! The fully adjustable steering column and technology at your fingertips in the easily accessible best in market air suspended AutoComfort cab make the Q Series a dream to drive and a pleasure to work with.

PAGE 10 AND PAGE 18

5. FARMING FOR TODAY AND TOMORROW

BUILT FOR SUSTAINABILITY.

The Q Series is the smart farming tractor designed to maximise your yields and minimise inputs and is built in Finland by the most sustainable tractor brand in the world.

PAGE 20-26

6. 365 NIGHT AND DAY VISIBILITY

WORK, NO MATTER WHAT THE WEATHER. 24/7.

With 6.5 square metres of glass, a market-leading 270-degree wiper, and excellent working lights, you will be able to see what you are doing –see well in every situation.

PAGE 14

7. WORK AT FULL CAPACITY

BUILT FOR BIG JOBS. RESPONDS WITH PRECISION.

The large, 75-litre oil capacity hydraulics and 200-litre pump with ECO option are made for lifting large implements.

PAGE 12



8. BIG BEAST. LIGHT FEET.

A COMPACT TRACTOR THAT CAN GET BIG WHEN NEEDED.

A low own weight of 9200 kg makes the Q Series a nimble and agile high horsepower Beast that can guarantee a high payload!

PAGE 16

9. WORK WHICHEVER WAY YOU WANT

SAVE TIME AND SAVE YOUR BACK WITH TWINTRAC.

With TwinTrac by Valtra you can easily turn the Q Series driving position 180 degrees and take full advantage of rear implements and market-leading visibility for working the right way round.

PAGE 18

10. UNLIMITED POSSIBILITIES

PRESTIGE, PRODUCTIVITY, AND PROFITABILITY.

True versatility comes from Unlimited tailoring to your exact needs, increasing profit, productivity and prestige.

PAGE 28

WORKS LIKE A BEAST: SMART POWER

The large engine is only the tip of the iceberg. The power you need from the Q Series to work like a Beast is intelligently employed and directed to where you need it when you need it. The EcoPower concept is built for heavy pulling, ensuring the high torque and solid sturdiness of the tried and tested AGCO engine is utilised at low revs and remains consistently high throughout the 1500 to 1800 rpm range. Maximum power is reached at 1850 rpm.

A RELIABLE ENGINE

The Q Series' tried and tested 6-cylinder 7.4-litre AGCO Power engine is a popular and proven winner from Valtra's T Series tractor.

Intelligent innovations like single non-variable geometry turbo improve efficiency, while the hydraulic lash adjustment ensures easy and cost-effective servicing. The

sophisticated yet robust exhaust after-treatment not only makes the engine run cleaner but also reduces engine congestion, for smoother running and lower service costs. With NO exhaust recirculation, the Q's engine remains clean and efficient. The air intake is placed higher for cleaner, fresher air.

MAX POWER. LOW REVS

Save fuel and lower emissions without compromising on power. Valtra's low rpm, max power, concept, known as the EcoPower principle is used throughout the entire Q Series range. In the Q305 boost power is always available. Other models feature a straightforward boost feature to provide extra power when you need

it most. Transport boost is fully available when ground speed reaches 18 km/h, while Sigma Power boosts the PTO if used on the go. In the Q305 this feature is also available when stationary.



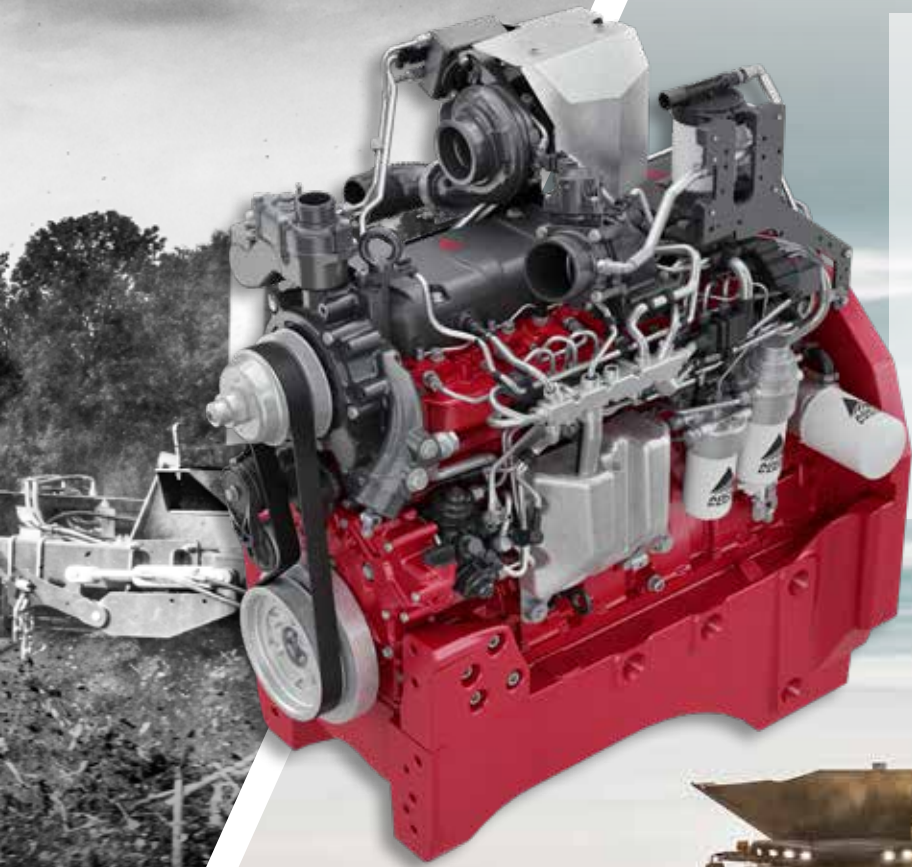

TOTAL TORQUE

Get more done with less stress for you and the engine as all Q Series have a low rated speed of 1950 rpm. Maximum power is reached at 1850 rpm, and the power output remains reliably high in the range of 1500 to 1800 rpm. Thanks to the Permatorque feature, at low revs of 1000 to 1500 rpm the Q Series achieves an excellent 1280 Nm of torque!

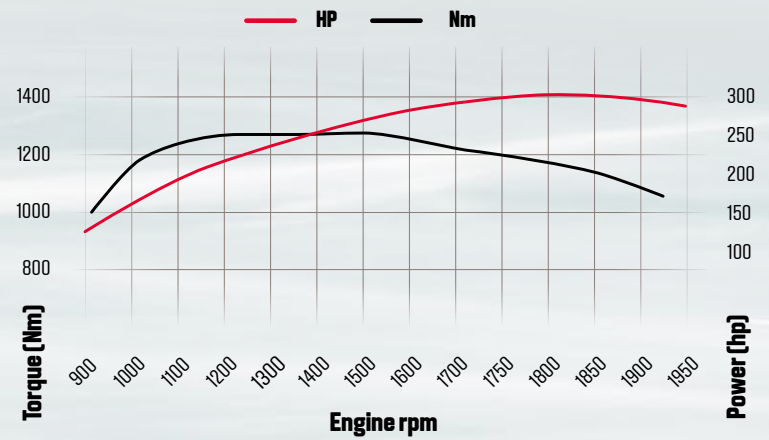

A TRUSTED TRANSMISSION

The Q Series CVT transmission was designed and developed in-house by AGCO, in Germany, ensuring a perfect fit with Valtra.

A POWERTRAIN YOU CAN GET ON BOARD WITH

Pairing a tried and trusted 6-cylinder engine with a proven, reliable CVT transmission has given rise to a winning powertrain you can rely on to deliver the power you need when you need it.

A SMART TRANSMISSION

The Q Series has the smoothest ride possible thanks to the smart CVT transmission that offers smooth stepless power delivery, even at low revs, saving fuel. Just power when you need it.

The power train is simple and easy to manage through the SmartTouch user interface. The transmission can be operated in two modes - manual and automatic. Automatic mode offers unparalleled ease of use. In automatic mode, the Q Series electronic transmission management automatically

selects the lowest possible engine revs to maintain the lowest fuel consumption. You work the way you want and let the Q think like a Pro for you. The driver simply sets the speed using the drive pedal, drive lever, or cruise control, whichever best suits the driver or task. With droop control the operator can change the behaviour of the tractor for even more economic or intensive operating to save either fuel or time, depending on your cost-saving preferences.

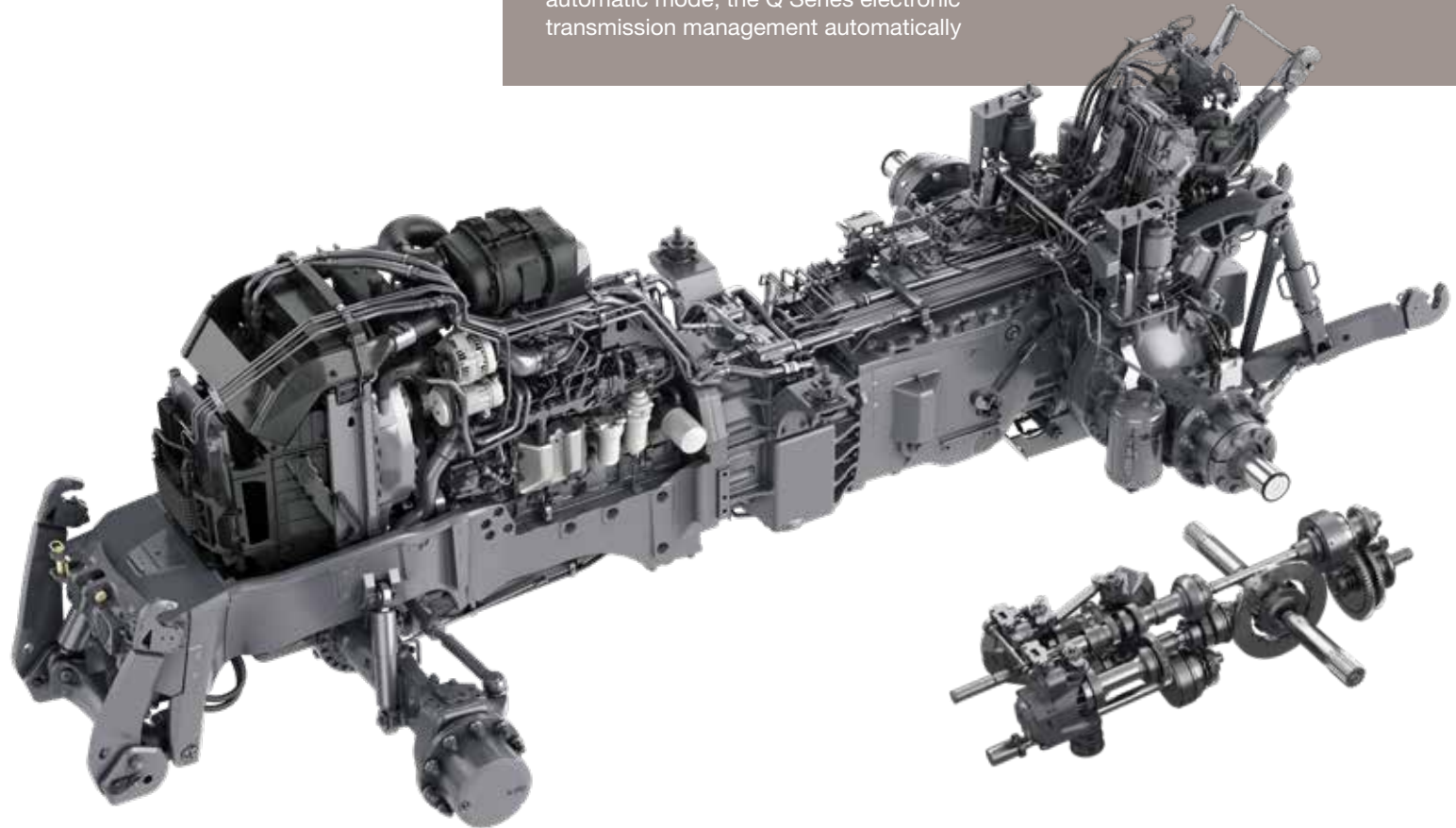



FIELD EFFICIENCY. FUEL ECONOMY.

You can easily get the Q Series to work in the most efficient way. When more power is needed, in automatic mode the engine will automatically increase revs to match the workload. When the power requirement decreases the engine revs automatically decrease, saving fuel.

The CVT transmission has two work areas, A and B which both start at 0 km/h. A is made for fieldwork and heavy pulling tasks while B is ideal for road driving. Reverse speeds are up to 38 km/h.

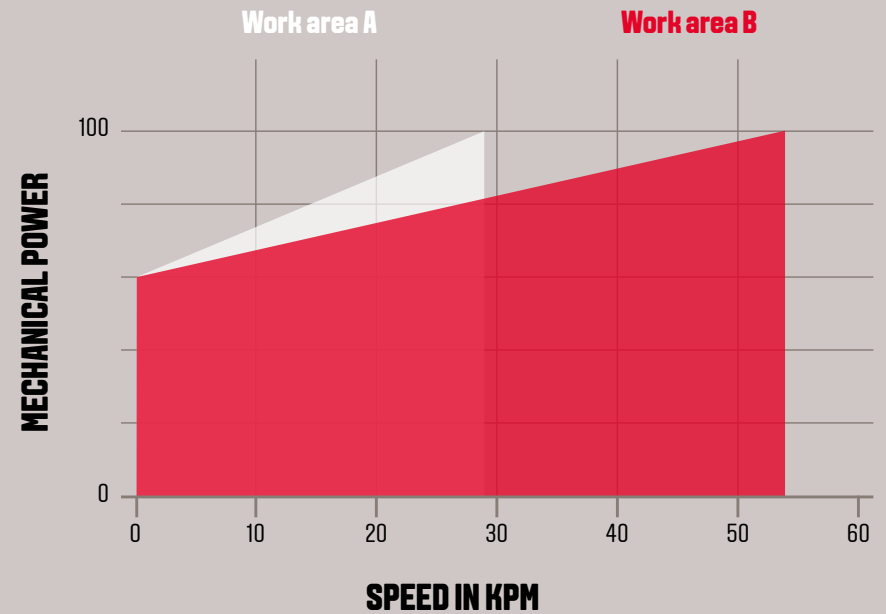

THE SMOOTHEST RIDE ALL DAY LONG

Just sit back, relax, and let the Q Series do the hard work! The CVT transmission ensures the correct engine speed for any work. In most

cases this is just under 1500 r/min. This helps to keep fuel consumption low while maintaining the capacity to easily clear peak loads.

SUPERIOR SUSPENSION

At Valtra, we consider your comfort our responsibility. Long days in the field and on the road needn't take their toll. Your work environment needs to be relaxing, safe, and comfortable. The all-new Q Series is designed around the driver with air suspended cab and luxurious seating options to provide maximum comfort and ergonomics all day long.



ALL DAY COMFORT

The Q Series comes with the optional AutoComfort cab suspension system which automatically adjusts to different driving conditions and situations, instantaneously.

AutoComfort utilizes Valtra's CANbus system to continuously communicate

between shock absorbers, position sensors, and a control unit, adjusting the stiffness of the shock absorbers constantly, based on movement data from the position sensor and information on the position of the shuttle and brakes provided by CANbus. Air springs on the cab maintain a steady height regardless of load.



AIRES FRONT AXLE

Valtra has over 25 years of experience with air-suspended front axles. The Aires pneumatic front axle suspension offers a smooth ride and absorbs the shocks of uneven roads and fields, managing high traction with +/- 9-degree suspended oscillation and +/- 50 mm suspension travel.

ROBUST MECHANICS

Trouble-free operation of the suspension is guaranteed, and there are no service points, as the suspension mechanics are as robust and simple as can be with two air bellows, automatic level control and robust shock absorbers. The long swing axle with support in the middle chassis stabilises movements.

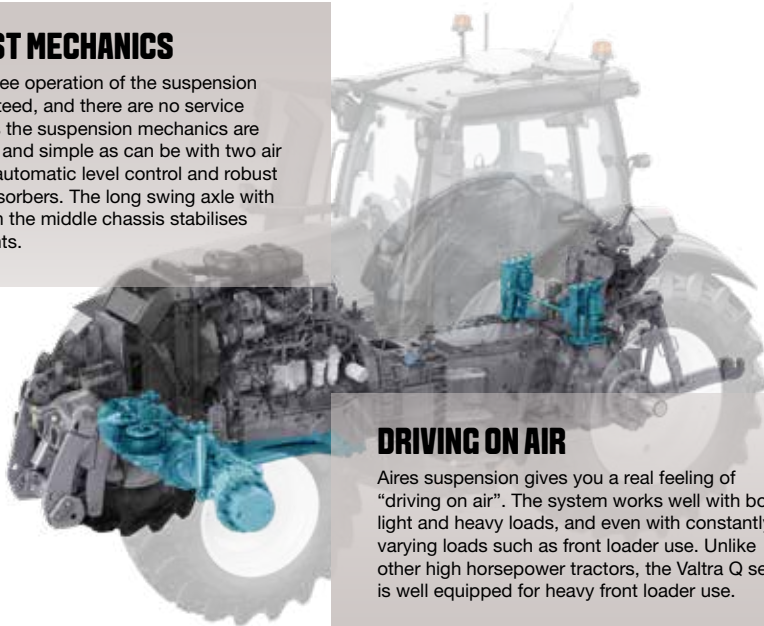

DRIVING ON AIR

Aires suspension gives you a real feeling of "driving on air". The system works well with both light and heavy loads, and even with constantly varying loads such as front loader use. Unlike other high horsepower tractors, the Valtra Q series is well equipped for heavy front loader use.

A SMOOTH RIDE, WHATEVER THE WEATHER

Unlike oil, air does not suffer from changes in viscosity as the temperature fluctuates. This means with the Aires front axle suspension you can be assured that your ride will be consistently smooth even through the hot summer or on the coldest of winter days.

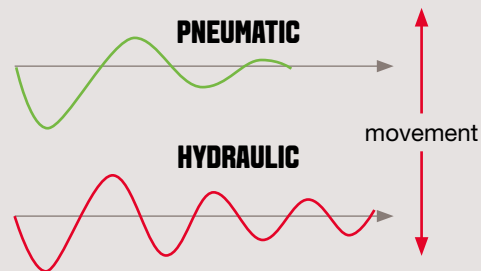

HEAVY-WEIGHT HYDRAULICS

The Q Series has heavy-duty load sensing hydraulics, made for working with big implements - with big needs. The separate hydraulic oil reservoir has a capacity of 75 litres. All of which is available for implements. The implement hoses are easy to fit due to the easy-to-use decompressing levers.



WORK AT FULL CAPACITY

The Q Series is a beast that can lift 4800 kg at the front and 10000 kg at the rear linkage. The standard hydraulic pump delivers 200+ l/min at nominal engine revs and with the ECO option this flow is achieved already at 1650 rpm. Being a real Pro, all hydraulic

controls are managed electronically from the SmartTouch interface and their functions and settings can be integrated into the comprehensive but easy-to-use U-pilot headland management.



EASY HITCH AND GO

The Q Series offers a comprehensive selection of trailer hitches for different user demands and market areas.



PTO ON THE GO

The heavy-duty two speed PTO can be easily controlled from the SmartTouch user interface or from outside via the simple controls found on the mudguard. The PTO axle is interchangeable.



LINK LIKE A PRO

The Q Series is made for working with large implements. The HD 3-point linkage is designed well, with a strong geometric form and 100 mm lift cylinders. The two lifting rods have two positions. In the foremost position, they have a maximum lift force of 100 kN, while in the rearmost position this is increased to 108 kN.

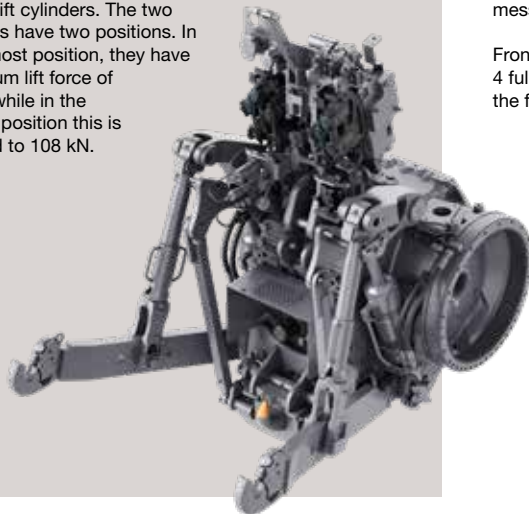

DCUP VALVES

At the rear of the Q Series, there are up to 5 fully adjustable spool valves. The standard valves have a peak flow rate of 120 l/min, and the optional highline valves have a flow rate of 140 l/min as well as decompressing lever release. The easy valve release and covers make attaching implements quick and easy with no mess. Power beyond this can be combined in all options.

Front lift, front quick couplers and even front loaders can be controlled with up to 4 fully adjustable electronic valves. Also, the free flow return feature is available at the front.



WORK LATE WORK LIGHT

Turn night into day with the Q Series' comprehensive and smart lighting options. In addition to the comprehensive LED work light package, superior LED driving lights are also available. Stylish LED daytime running lights are standard.

Intelligent lighting automation and control with SmartTouch means you can see what you're doing, and concentrate on the task at hand.

365 DAY AND NIGHT VISIBILITY

Working long hours into the evening, you need to see more than just what's in front of you. You need to see everything around you. LED daytime driving lights meet road standards and are automatically turned on and off according to what other lights are selected. The two-piece upper headlights offer superior illumination and can be used in both lower (dipped) and upper (full beam) positions.

Work lights are thoughtfully mounted around the tractor to provide 360-degree illumination. The energy-efficient integrated front LED working lights in Valtra's 'hockey-stick' form give a combined 8000 lumens of lighting where you need it most. The other eight work lights provide bright illumination all around the tractor.

The SkyView cab option comes with two additional work lights mounted to the rear. Another nice detail is the detachable flashlight/torch which is located just inside the cab.

Of course, the lighting story doesn't end there. With a range of additional work and safety lights available from Unlimited, the possibilities are endless.





BE SEEN. BE SAFE.

The all-new Q Series features two rear indicators integrated into the cab for enhanced safety, while maintaining stylish looks.

360 DEGREE VISIBILITY DAY AND NIGHT

Integrated front, side, rear, and cab working lights are carefully positioned to provide total 360 degree visibility throughout the night.



SAFE AND EASY LINKING

At the rear of the tractor, a dedicated linkage light is carefully positioned to provide bright, clear light so you can hitch in ease, whatever the time of day.

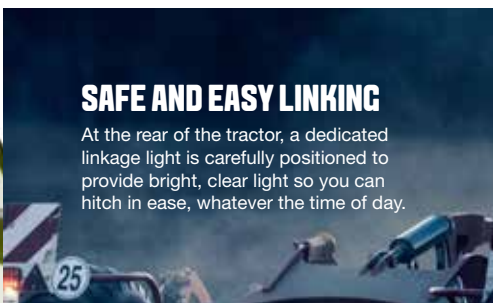

SEE WHAT YOU'RE DOING

Small but clever details make all the difference! Such as the LED step lights that illuminate your entry to the cab for safe and easy access.



INTELLIGENT ILLUMINATION

Working light configuration can be swiftly and easily managed from the SmartTouch terminal. However, the Q Series also offers several automated options that make your life easier. The auto-beacons automatically come on when the tractor is moving at more than 25 km/h. Similarly, the cornering lights also automatically engage when the tractor is turning, and the rear work lights automatically come on when reversing. The Q Series' 'follow-me-home' function keeps the front waist level working lights on for 30 seconds after you leave the cab.



A WELL BALANCED BEAST

Minimise soil compaction and maximise yields. With an operating weight of 9200 Kg and a max gross weight of 16 T, the Q Series is an agile Beast with a huge payload. The low height, long wheelbase, and light frame give the Q Series an excellent low centre of gravity. An array of ballasting options means that the Beast can get heavy when needed -just configure the Q Series for the implement and task at hand. You can spread the weight accordingly while avoiding unnecessary soil compaction.

MINIMUM IMPACT. MAXIMUM YIELD

From the ground up, your soil is your best resource. Better soil health means better yields. When soil gets compacted, it becomes less porous. This negatively impacts drainage, the exchange of gasses between the air and soil, and ultimately the soil's microbiome. A healthy soil structure and microbiome equate directly to better plant health and higher yields. Avoiding soil compaction, therefore, has to be a priority.

The Q Series is a big Beast that is gentle on the soil. When heavy tractors drive on friable soil they sink in creating a ridge of soil on the leading edge of the tyre that creates resistance. A low machine weight means the Q Series sinks into the soil less. In turn, the so-called bulldozing effect where soil builds up in front of the wheel is reduced. Even a slight sinkage of 1 cm can impact fuel consumption by as much as 10%.

Weight distribution is perfectly balanced thanks to the 41% front axle / 59% rear axle division. Ballasting options allow operators to spread the weight across the tractor according to the needs of different tasks and implements. This prevents slippage and smearing of the soil. Optional automated tyre inflation systems increase the surface area of the tyres in contact with the soil, according to conditions, minimising compaction.

Even light compaction can take its toll over time. Smart Technologies like Valtra Guide and Section Control come as standard with the Q Series. These technologies allow you to use the same waylines year after year with no drift and get more done in fewer passes. Less driving on the soil results in less compaction and increased yields.



A BALASTING ACT

Front ballasting options from 600 Kg to 2400 Kg and belly weight ballasting mean you can configure the Q Series exactly as you need it to work with large implements or work tread lightly when you need. Rear wheel weights can easily be added to maintain good traction.



BALAST OPTIONS

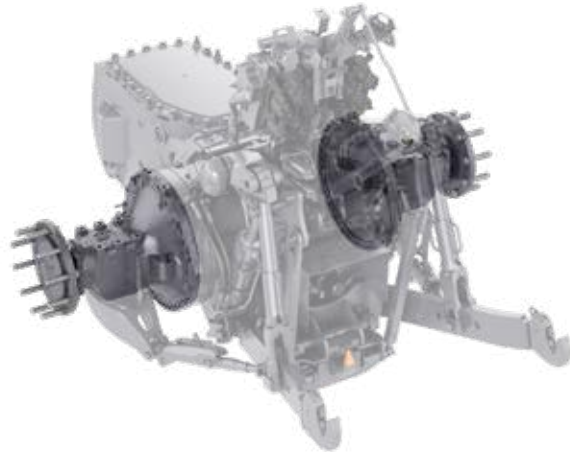

Belly weight
180kg



Counterweight
600kg



Counterweight
600kg + 600kg



Counterweight
2300kg

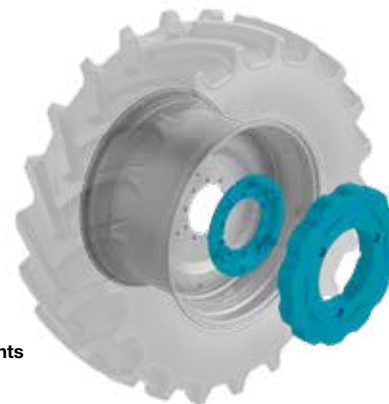

Rear wheel weights
250kg, each side



Rear wheel weights
250kg + 250kg,
each side

COMPLETE COMFORT

The Q Series is a pleasure to work with and a dream to drive. The Q is also a Pro when it comes to health and safety. The combination of the excellent ride position, high amount of glass, and clever positioning of exhaust and other elements mean the operator has a clear and unobstructed view all day long. No more twisting and turning in the seat to get a good view. You'll finish your work day in as good condition as when you started. Clever design details such as innovative storage and the large coolbox combine with the premium interior and excellent air conditioning to make your work environment as comfortable and efficient as possible.

The Q Series really takes the stress out of operating a high horsepower tractor for long days. With integrated smart technology, drivers can take full advantage of Valtra Guide to navigate through the field and with SmartTurn automatically turn the tractor at the headland.

DESIGNED AROUND YOU

Taking inspiration from the popular, tried and tested T Series cab, Valtra has designed the Q Series to be ergonomic and provide all-day comfort for the driver. As you step into the air-suspended cab using the easy 4 step access, you notice the Quality and attention to detail. The 6.2 m² of glass

gives unparalleled visibility, enhanced by the 270-degree front wiper and full 180-degree side wiper. The Pro feeling continues as you sit in the premium, Air-conditioned (option), seat, which automatically adjusts to the driver's weight.

The Q Series work environment is physically and digitally customisable to maximise your comfort and productivity. The steering wheel is quickly and easily adjusted using the steering wheel tilt pedal. Similarly, SmartTouch driver profiles can be stored and easily recalled when switching shifts.

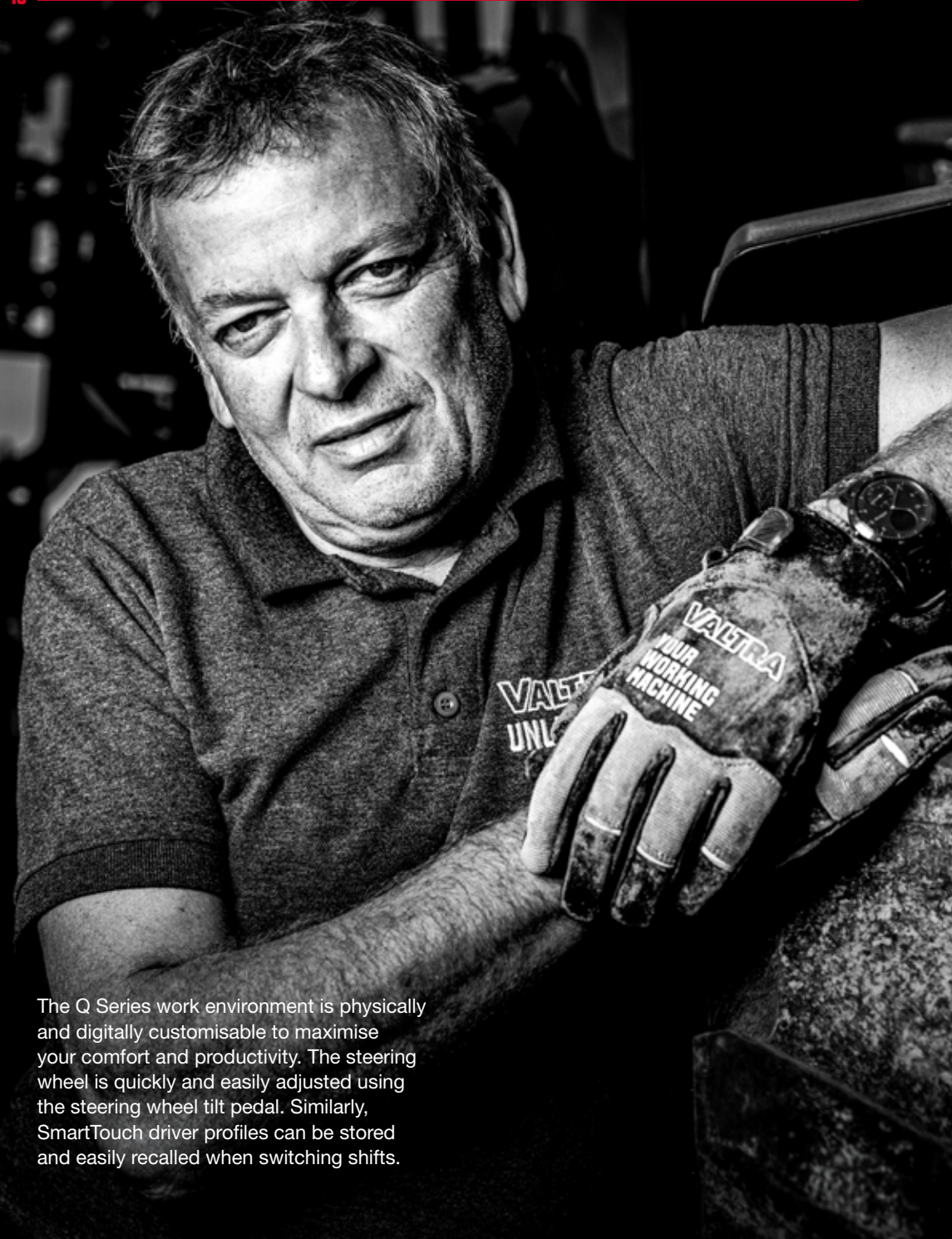

YOUR COMPLETE COMFORTS

ALL AROUND AIR CONDITIONING

The Q Series has creative climate control solutions. Heating comes from the leg area and rises up to heat the whole cab. Cooling air conditioning comes from around the upper body, helping you keep a cool head. In total, 12 air vents ensure fresh air is distributed evenly around the cab.

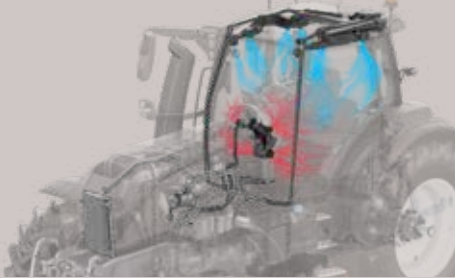

FUNCTIONAL SEATING

The driver's seat offers uncompromising comfort and an array of personalised adjustments. All three seat specification levels include heating, while the highest spec (Evolution) also includes cooling. When folded, the passenger seat can also be used as a table for the driver.

PREMIUM INTERIOR

The Q Series stylish interior includes a leather steering wheel, a dark material palette and chrome detailing. Charge your phone while you work with the premium phone holder and two 18 w USB charging ports.

SKYVIEW

The state-of-the-art Skyview cab is designed to match the demanding needs of contractors. The large polycarbonate window with wiper gives an unparalleled view of cranes and side-mounted implements. The cab is fully FOPS proof for enhanced safety.



COOL BOX FOR HOT WORK

The Q Series comes with an integrated coolbox to keep your lunch cool on long hot days.

TWINTRAC

Take full advantage of the heavy lift capabilities, complete hydraulics, and heavy-duty PTO by operating the Q Series in reverse using the innovative factory-fitted TwinTrac reverse drive system. TwinTrac saves time, saves fuel, prevents straining injuries, and improves efficiency thanks to increased maneuverability and unrivalled visibility.



POWER SHUTTLE

The newly designed power shuttle lever is a revolution in ease of use. Automatically returning to the centre position after selecting the drive position, it is easy to switch to digital SmartTouch lever shuttle control, meaning there is no need for the driver to separately engage the shuttle when using TwinTrac.

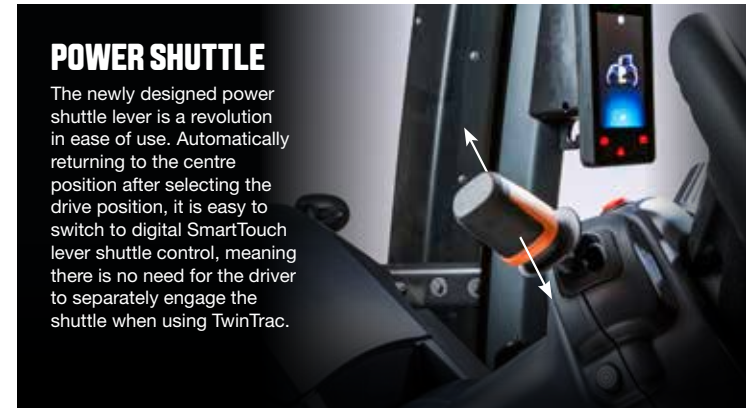

THINKS LIKE A PRO: SMART TECHNOLOGY

Smart farming is essential to more efficient, profitable, and sustainable agriculture. Our innovative and popular SmartTouch armrest puts the power of smart farming at your fingertips. Tasks are managed with simple and familiar swipe and tap movements, just like a smartphone... only easier! Operator profiles and tasks can easily be shared between tractors in a fleet, meaning any driver can step into any cab and get to work straight away.



SMARTTOUCH

The award-winning Valtra SmartTouch armrest user interface is a complete operating environment designed to be ergonomic and intuitive.

It features an easy-to-use 9-inch touchscreen and multifunctional lever. The multifunctional lever puts ultimate control in the hands of the operator with an easy and ergonomic vertical design where the tractor's speed can be managed using only the multifunction lever. In addition, using the lever, operators can control the powerlift, hydraulics, and ISOBUS implements.



HEADLAND MANAGEMENT WITHOUT THE HEADACHE

Valtra SmartTouch offers the easiest headland management system. With Auto U-Pilot, you can configure your sequence by recording while driving or programming it when stationary using the 9" touch screen. The M1, M2 and M3 buttons can be programmed for three completely different sequences - which can manage up to 24 operations each. All settings are saved in the appropriate profile (e.g. ploughing).

A JOYSTICK THAT'S A JOY TO USE

Valtra's innovative and ergonomic SmartTouch joystick is a fully programmable hydraulic control for front and rear-mounted implements. The live third function lever can be programmed to control your most common function while still manoeuvring with the joystick.

RADIO AND PHONE CONTROL

Take calls and manage your media right from SmartTouch with phone integration.

LOOKING SMART

With SmartTouch, SmartTouch Extend and the A-Pillar display, the Q Series cab turns into a smart cockpit displaying all the information you need to work efficiently, comfortably, and productively.

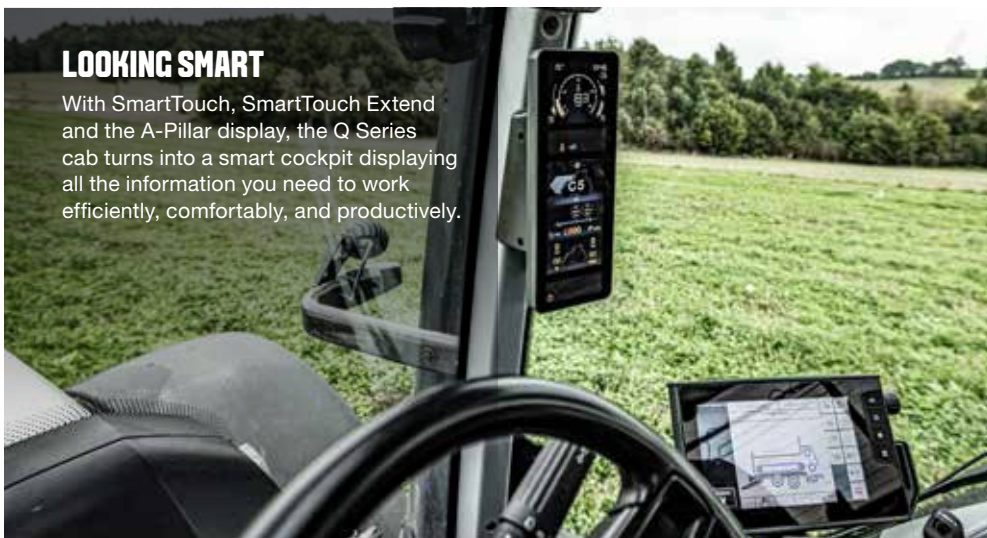

SMARTTOUCH EXTEND - DOUBLE THE DISPLAY

The SmartTouch Extend second terminal is the perfect addition to SmartTouch for advanced ISOBUS applications. Configure and display your ISOBUS implement or Valtra Guide operations right at your fingertips and at eye level to get a full picture of your operation for enhanced productivity. SmartTouch Extend can also be used as a camera display.



CAMERA DISPLAY

Increase rear visibility and safety by using the SmartTouch touchscreen as a camera display.



A-PILLAR DISPLAY

The large A-Pillar console is located at eye level and within easy reach to improve the safety and convenience of the driver. The clear display shows all the tractor information the operator needs when working. Key information is easily and instinctively controlled, by a simple rotating encoder and two buttons. On the road, the A-Pillar display automatically dims non-essential information so the driver can concentrate on the road.

TOP

The top of the display shows essential information such as your ground speed, clock time, engine RPM and fuel levels, prioritising the information you need to work efficiently and safely. When needed, the rest of the display can be dimmed to minimise distractions.

MIDDLE AND BOTTOM

The middle and lower screens show the tractor's transmission status and performance, including CVT settings and cruise speeds. Drivers can configure the two lower areas of the screen to display information that is essential to their tasks and individual needs.

INFORMATION AND WARNING LIGHTS

Key information and warning lights are displayed in two rows of LED lights that light up when needed, ensuring the driver is immediately aware of any potential issues improving safety and uptime.



TECHNOLOGY AT YOUR FINGERTIPS

The Q Series is a smart farming Pro that makes your work easier, faster, more efficient, and more productive. Valtra's smart farming technologies work seamlessly together – Valtra Guide, ISOBUS, Section Control with Multiboom, Variable Rate Control, Valtra Auto U-Pilot, and SmartTurn, to improve accuracy, profitability and sustainability.

All smart farming features are controlled smartly and simply from the SmartTouch user interface. Task profiles can be stored so that it only takes a few swipes and taps to start tasks. Your Q certified dealer has expert smart farming knowledge, and is there to make sure your smart farming features are set up and running straight away.

ACCURACY EQUALS PROFITS

Valtra Guide is the key to your smart farming. But you gain the profits with the Valtra Variable rate control's superb application rate accuracy.

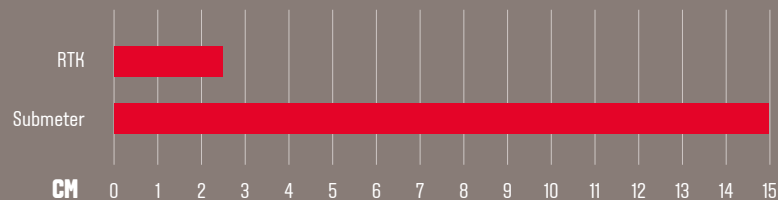

SATELLITE SIGNAL RECEIVER OPTIONS

Valtra offers two Global Navigation Satellite System (GNSS) receiver options. Choose from either Novatel Smart7 or Trimble AG-482, according to your needs. Both offer up to centimetre accuracy +/- 2cm, and are compatible with Valtra Guide.



VALTRA GUIDE

Valtra Guide is our auto-guidance solution and is the easiest to use on the market. It has been developed based on real user feedback. The automatic steering uses GPS to follow waylines precisely and reduces overlaps, saving you time, fuel and money. Minimising the need to steer, means new and seasoned drivers alike can concentrate on the implement and the job at hand, increasing precision and safety while reducing fatigue, overlap, and time spent in the field.

With Valtra Guide, recording and configuring waylines and field boundaries is easy. By precisely configuring waylines and accurately sticking to them, total soil compaction is reduced, improving soil health and yields.



VALTRA AUTO U-PILOT HEADLAND MANAGEMENT SYSTEM

With Auto U-Pilot you can start your headland management sequence automatically when the tractor goes over a set headland line, making work both perfectly precise and easy.

SMARTTURN

With SmartTurn the field operating experience becomes fully automated, freeing the drivers' attention to focus fully on the implement and task at hand. Choose between automatic turning patterns to minimise soil compaction, and increase speed and efficiency. We recommend combining our Valtra Auto U-Pilot feature with the SmartTurn feature because then every pass and every turn will be fully consistent. Hence one can avoid unnecessary turns and overlapping errors while making the work as easy as possible by alleviating the stress and fatigue of long days spent in the field.

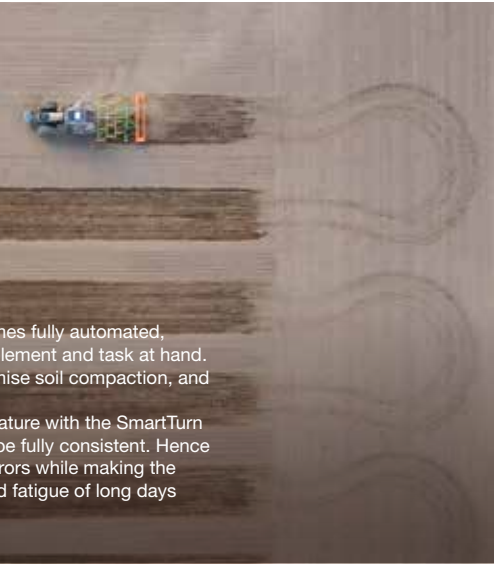

VALTRA SECTION CONTROL WITH MULTIBOOM

Valtra Section Control is the easiest to set up and operate section control system on the market. It automatically turns rows and boom sections on and off to eliminate overlap and avoid gaps. The Multiboom feature allows up to three booms of ISOBUS implements to be controlled at once. Section Control makes it easy to plan, save and recall work and settings for each field, giving you high precision, even with large implements and even in poor visibility. Section Control works with all compatible ISOBUS implements that comply with the ISO 11783 standard and that support Section Control functionality.

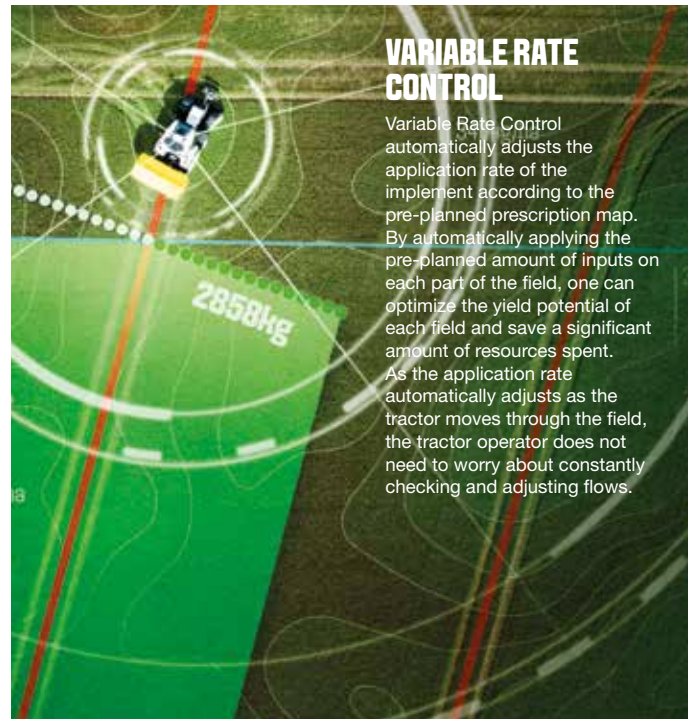

VARIABLE RATE CONTROL

Variable Rate Control automatically adjusts the application rate of the implement according to the pre-planned prescription map. By automatically applying the pre-planned amount of inputs on each part of the field, one can optimize the yield potential of each field and save a significant amount of resources spent. As the application rate automatically adjusts as the tractor moves through the field, the tractor operator does not need to worry about constantly checking and adjusting flows.

ISOBUS

With Valtra SmartTouch and ISOBUS, you can work with any ISOBUS-compatible implement, from any manufacturer.

SmartTouch lets you connect implements quickly and easily, plus it gives you the high level of control that precision farming demands. The ISOBUS standard (ISO 11783) is what makes this possible.

ISOBUS makes compatible implements "Plug and Play", so when you connect the implement to your Valtra tractor, all the relevant machine data is uploaded to the terminal without any extra cables or screens blocking visibility.



MACHINE MANAGEMENT

The Q Series is a Beast equally at home working on its own or seamlessly as part of a larger fleet. Whether working with one tractor or managing a fleet of machines, reliability, accuracy, and simplicity are important in making business easier and more profitable. Valtra's telemetry and connectivity solutions help you keep on top of what your Q Series is/are doing in real-time, and automate data gathering and processing for easier reporting and document generation.

VALTRA CONNECT

Sync like a Pro! If you're serious about saving time and money to improve your bottom line, then the Q Series' telemetry will suit you and your business perfectly. Valtra Connect is our telemetry solution that records tractor activity and GPS movements in real time. Data is the key to making informed decisions. By collecting data on tractor movement, inactivity, and general logistics, you can optimise your plans and act accordingly. Valtra Connect allows you to monitor a whole fleet and receive status information delivered to your mobile device in real-time and historically. With Connect, you can create simple, easy-to-read performance reports tailored to a time frame of your choosing. These reports can be exported as PDFs for easy sharing. Access your data anytime, anywhere. The geofencing feature notifies you when any of your tractors leave a defined area, improving safety and protecting your investment. Using diagnostic data, you and your Valtra service partner can anticipate maintenance needs and react faster to solve minor issues before they become a problem. This can prevent downtime, and allow you to plan service time to when it suits you best.



AGCO telemetry for customer
Fully customer and user driven user experience



AGRIROUTER

Work with any implement and across different FMIS without fuss. The Q is a Pro team player. Agrirouter is the technology that powers Valtra's farming connectivity solutions. Agrirouter is a universal system that facilitates data transfer between machines and agricultural software, no matter what the manufacturer or vendor. As Valtra is an Agrirouter trusted partner you can be assured your Q Series will fully integrate with your Agrirouter compatible Farm Management Information System (FMIS). As Agrirouter is a universal industry standard, you can choose to share information with trusted external partners such as contractors, dealers, and service providers to ensure the very best service, minimise downtime, and maximise time in the field.



Machinery Manufacturer

App Provider

Input Companies

Food Processing Industry

External Data-Exchange Platforms

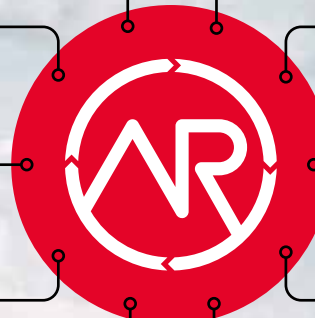

Farmer



Contractor



Dealer



Adviser



External Service Provider



TASKDOC® PRO

Whether managing one tractor or a fleet of several, TaskDoc® Pro saves you time doing paperwork. TaskDoc Pro® is 100% ISOBUS-compatible supporting ISOBUS standards TC-BAS and TC-GEO. It works with Farm Management Information Systems (FMIS) to automate data collection, help manage your work, and supports compliance with an expanding range of statutory documentation. With TaskDoc Pro, you can pre-plan smart farming operations from your office as and when you like. Securely and simply transfer accurately-planned tasks between your computer and tractors via a normal USB stick or mobile/cellular network.

With TaskDoc Pro there's less paperwork. While the tractor is working integrated onboard calculators wirelessly record data from the tractor and ISOBUS implement such as areas worked, fuel consumed, and time spent. At the end of the task, all the data you need for document production will be created automatically. You get accurate records of completed tasks and actual application rates delivered straight to your computer. Any time. Anywhere.

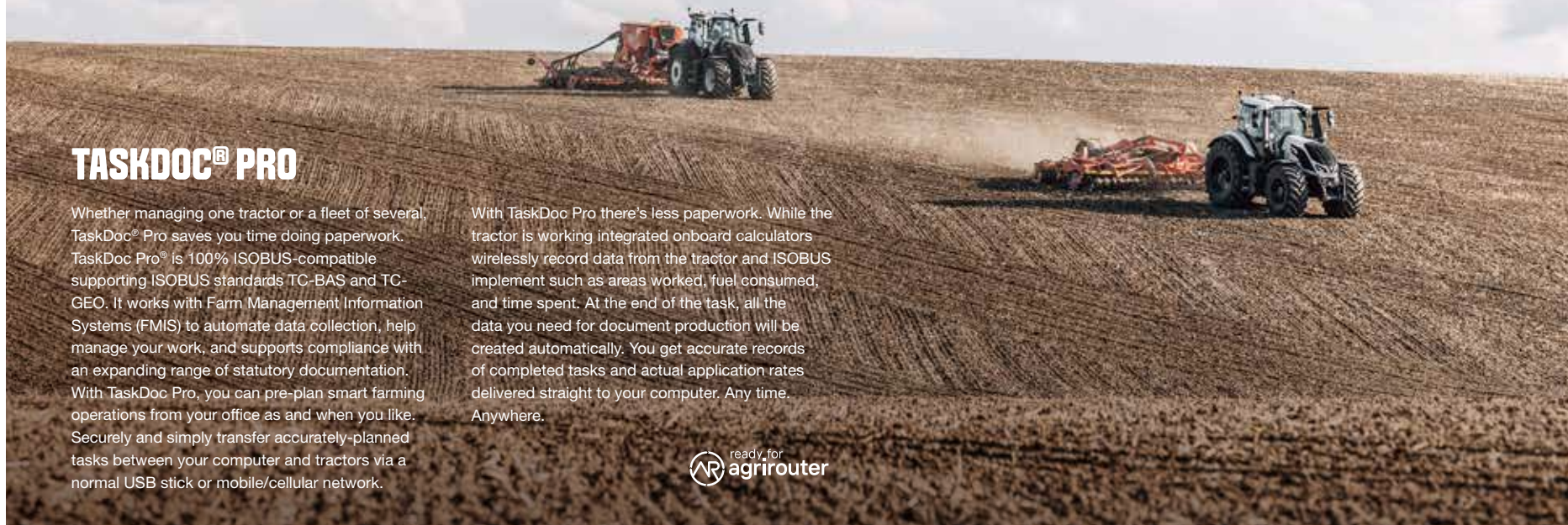

MAXIMUM UPTIME

Working long hours and to tight deadlines you know your Q Series will be there providing 101% uptime. The Q Series is a high-performance pedigree Beast that performs every day. Like any Pro, the Q Series needs a dedicated team behind it. We're here with you 24/7. It's our job to make your tractor experience the best it can be. Our easy Connect, Care & Go service concept offers unrivalled practicality. From the moment you purchase your Q Series, your specialist Q certified dealer is there to serve you. Choose to share data with trusted service partners and they will know the health and status of your machine at the same time you do. Together you can plan maintenance for when it suits you best and know you will always have access to a courtesy Q Series.

YOUR OWN Q CERTIFIED DEALER

To keep you working at 100% efficiency, get the most out of the productivity benefits of your Q Series, and support your business needs, Valtra has identified the very best dealers and service partners for the Q Series. Only dedicated Q certified dealers are qualified to sell the Q Series. Valtra has initiated a new set of brand experience standards for all Q certified dealers that cover both machine acquisition and after-sales experiences. Q dealers will hold a sufficiently high stock of spare parts with the capacity for scaling volumes, regularly train service staff, utilise the latest diagnostic tools and follow Valtra's quality after-sales

procedures. Q Series customers can expect a high-quality machine handover experience. We want to make sure your Q Series is set up with your implements and all smart farming capabilities from day one.

Your Valtra Q certified dealer represents the best tractor, implement, and smart farming expertise in your area. You can always rely on your Q certified dealer for the best service; from consultancy, maintenance, repair and spare parts, to the purchase of a new piece of equipment.

PEACE OF MIND. IN YOUR HANDS.

You want your Q Series to work hard for you. You want comfort and convenience. Our finance solutions are just like that. They are conveniently available through your Valtra Q certified dealer. You get affordable financing in one clear package, powered by AGCO Finance, the global provider of financing solutions for Valtra. With over 30 years of agricultural industry experience, you can count on getting customized financing solutions from industry specialists.

With the Rent, Buy, Lease programme, we can build a financing solution to meet your individual and specific needs.

With Connect, Care & Go, you get peace of mind knowing that service costs are factored into your monthly outgoings. You will get a solution that fits your needs.



CONNECT

TRACTOR DATA, INFORMATION AND SERVICES.



CARE

FACTORY EXTENDED WARRANTY.



GO

MAINTENANCE CONTRACT.





101%
CONNECTED

HANDOVER

DEMONSTRATIONS
Dealer test track
Customer farm

VALTRA
CERTIFIED DEALER
AT THE EXPERIENCE CORNER

HANDOVER
Connected
Driver training

DEMO TRACTORS

CUSTOMER PARKING

DEMO TRACTORS

VALTRA
DEALER NAME
ADCO

DIGITAL TOOLS

SALES OFFICES

VALTRA

SERVICE
Spare parts
Workshop

Configurator

Dealer website

Guided online sales

Pre-booking Online ordering

Virtual showroom

Valtracom

Buy
Rent
Lease

Connect
Demo

VALTRA

DEALER NAME

ADCO

YOU FIND THE WORK. WE'LL FIND THE WAY.

It's your tractor. Yours. Whatever your needs, wants, or desires. With accessories and options to tailor your tractor to suit your work, branding, or dreams, there's always a reason to go Unlimited. What do you need? What have you been dreaming of? Done and done. We make it happen.

PERFORMANCE FOR ANY PURPOSE

The Unlimited studio can fit any accessory or specialist equipment that is not available as standard from our production line. With Valtra Unlimited your tractor is a true multi-purpose vehicle, built according to your unique specifications, with the design, comfort, and the features you need to succeed in any environment.

FACTORY FITTED

The Unlimited Studio is located within the Valtra factory in Suolahti, Finland. All the accessories and equipment fitted by the Valtra Unlimited studio are covered by our factory warranty. We also supply all the servicing and spare parts for Unlimited fitted options. The accessories and equipment

available from the Unlimited Studio include additional working and warning lights, front loader scale, premium leather steering wheel and seats, a broad range of paint colours, central lubrication, stereo systems and much much more.



UNLIMITED FARMING FEATURES

The Unlimited Studio provides a range of options to enhance both the productivity and efficiency of the Q Series and the safety and comfort of the driver.

Unlimited offers an automatic central lubricating system that helps ensure your Q Series is always running smoothly and eliminates the need for laborious manual lubricating. Our intelligent central tyre inflation system saves time and money while protecting the structure of your soil and is easily controlled via SmartTouch.

Unlimited can fit many safety features, including LED Light bars, warning lights, and signaling panels to improve visibility and extend the safe working hours for operators.

Front loader scales improve the precision and efficiency of your work. Loaders can even be painted to match the tractor. With Unlimited, the Q Series looks even more the 'Pro' with a range of standard and metallic paint options and professional taping to ensure your fleet looks as professional as the work you do.

Unlimited options can enhance the ergonomics and comfort for the driver, such as relocation of the SmartTouch terminal, additional sun blinds, and a range of hard-wearing, professional trims like leather seats and steering wheel. With the Q Series, the Unlimited Studio brings Quality with a capital Q!



MUNICIPALITY

The Valtra Unlimited Studio fits specialist equipment that meets municipal standards and can replace many specialized vehicles, such as graders and sweepers significantly increasing efficiency and productivity.



AIRPORT MAINTENANCE

With the correct tools, such as ploughs, sweeper-blowers, and mowers, your Unlimited tractor can be utilised year-round.



FORESTRY

Unlimited offers a range of solutions to tailor your tractor for forestry use, including forestry tyres and LED working lights.

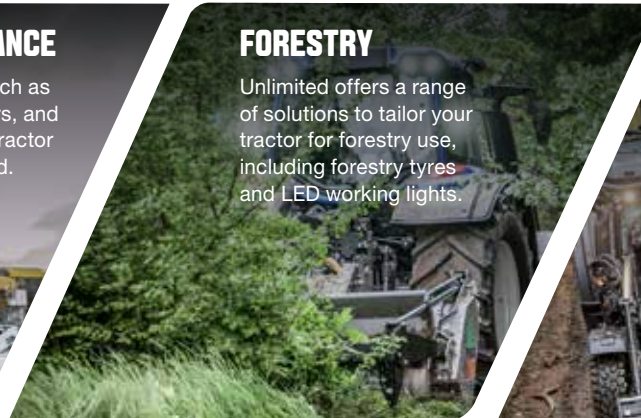

DEFENCE

With individually selected features, extreme manoeuvrability and powerful towing and load capacity, Valtra Unlimited tractors are the perfect choice for defence logistics.

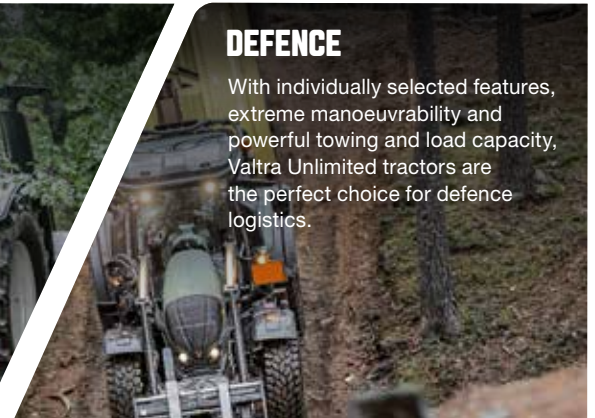

Q SERIES TECHNICAL SPECIFICATIONS

230-305 HP



MODEL	MAX POWER AT 1850 R/MIN (RATED SPEED 1950 R/MIN)						
	AGCO POWER	STD			BOOST		
		HP	kW	Nm	HP	kW	Nm
Q225	74 LFTN-D5	230	169	1000	250	184	1100
Q245		245	180	1100	265	195	1200
Q265		265	195	1200	290	213	1280
Q285		285	210	1280	305	224	1280
Q305		305	224	1280	305	224	1280

See specifications table for further engine data. Q225 - Q285: the boost values are available in road speeds as well as when power consumption from the hydraulics or in PTO increases and the tractor is moving. With the Q 305 model the transport boost steps in gradually and can be utilised at all speeds. The Q 305 model's boost is available for PTO use even when the tractor is stationary (tractor ground speed is 0 km/h).

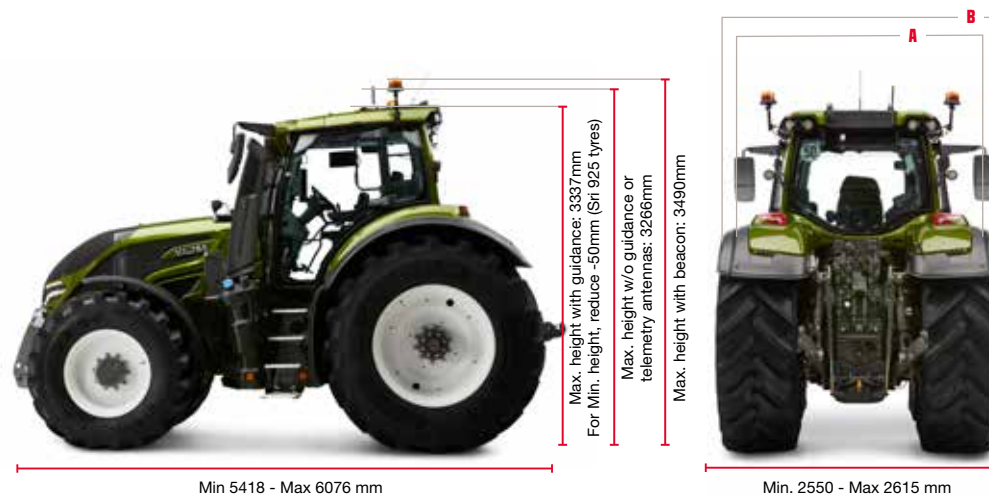

Weight:

Own working weight **9200 kg**
Max total weight **16000 kg**

Length:

No front lift **5461 mm**
Front lift in transport position **5556 mm**
Front lift in working position **6076 mm**

Mudguard widths:

A: narrow **2280 mm**
B: std **2550 mm**

MODEL	74 LFTN-D5	STD
	Q225-Q305	
DIMENSIONS WITH 710/70R42 + 600/70R30		
Wheel base [mm]	3050	
Length (with front linkage, transport position)	5556	
Transportation length, without front linkage	5461	
Height, with Valtra Guide box/telemetry, [mm]	3337	
Width, max [mm]	2615	
Turning radius [m]	6,75	
Ground clearance mid [mm]	565	
Ground clearance rear (no hitch) [mm]	588	
Weight (full tanks, + driver) [kg]	9200	
Weight distribution Front/Rear [%]	41/59	
Max total weight [kg]	16000	
Fuel capacity, basic [l]	430	
AdBlue, capacity [l]	45	
Min tyre size (rear SRI 925)	650/65R42 + 540/65R30	
Max tyre size (rear SRI 975)	710/70 R42	600/70 R30



MODEL	Q225-Q305
ENGINE	
Agco Power engine type	74 LFTN-D5
Engine no. of cylinders (volume, litres)	6 (7.4)
Engine speed at max power [r/min]	1850
Engine nominal speed [r/min]	1950
Engine speed at max torque [r/min]	1500
Idle speed [r/min]	850
Low idle (shuttle lever on P) [r/min]	750
Oil-change interval (h)	600
Emission grade	Stage V
Exhaust cleaning system	DOC + DPF + SCR
TRANSMISSION	
Number of gears	CVT
Number of work areas	2 (A, B)
STD speeds [km/h] Area A	0 - 28
STD speeds [km/h] Area B	0 - 53
Reverse Speeds	0 - 38
Top speed 43 km/ reached at [r/min] 1500	
Top speed 53 km/ reached at [r/min](option) 1500	
Front axle suspension	Pneumatic, AIRES

MODEL	Q225-Q305
HYDRAULICS	
Lifting power rear, (max kN)	100
Lifting power entire lift range, [kN]	95
Lifting power entire lift range, [Front, kN] option,	42
Type of Hydraulics	Closed center Load Sensing
Pump capacity std [l/min] at 1950 r/min	200
Pump capacity ECO [l/min] at 1650 r/min	200
Transmission and hydraulic oils	Separate oils
Exportable hydraulic oil [l]	75
Number of electrical service valves rear STD	4
Number of electrical service valves rear w. decompression	4 or 5
Number of electrical service valv. FRONT	2,3 or 4
PTO, 2 speeds	
2 Speeds @ engine speed [r/min]	540E@1577+ 1000@1882
2 Speeds @ engine speed [r/min]	1000E@1605 + 1000@1882
Front PTO option, speed @ eng. speed [r/min]	1000@1900
INTERFACES	
Valtra SmartTouch User Interface -- STD	
Valtra Connect	
Valtra Guide options	



You don't just work hard - You work smart.

You constantly work to improve efficiencies in workflow.

Managing your business to be profitable and sustainable.

Crops, clients, and livestock all need constant attention, and your time is precious.

You understand that you need the right power to get tasks done, but also the right data to be able to do it efficiently.

Whether you manage one tractor or a fleet, you demand uninterrupted connectivity and maximum uptime.

You need to know where your machines are, what they are doing, and how they are doing it to plan for your efficient and sustainable business.

You deserve a partner who understands this and works with you at every stage

That is why you trust Valtra.

We work hard to make hard work easy.

We make machines that are tough on the outside and smart on the inside.

Our machines are built to last.

Built to work. Built for you.

YOUR WORKING MACHINE



Valtra Inc.
Valmetinkatu 2
FI-44200 Suolahti
Tel. +358 (0)2045 501

www.valtra.com
showroom.valtra.com
www.youtube.com/valtravideos
www.facebook.com/ValtraGlobal

VALTRA is a worldwide brand of AGCO.

The tractors that appear in this brochure may be equipped with special options. Changes possible - all rights reserved.